

FLEX 2

LIGHTING

Table of Contents

Legend.....Page 1

Reverse Distribution Cable/
Reverse Lighting Cable.....Page 2

Whip End Extender Cable/
Reverse Splitter.....Page 3

Dust Cap.....Page 4

Single Circuit, Panel Switched.....Page 5

Single Level —
Lighting Circuit, Panel Switched
with Night Light.....Page 6

Dual Circuit, Panel Switched.....Page 7

Dual Circuit, Splitter Application with
Whip End Extender Cable.....Page 8

Hardwired Switching.....Page 9



ACS/Uni-Fab™

A PART OF **atkore**
INTERNATIONAL

260 Duchaine Blvd.
New Bedford, MA 02745
(508) 998-8277 • (800) 426-3170
Fax: (508) 998-7720
www.acsunifab.com

LEGEND

SYMBOL

COMPONENTS

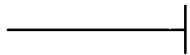

REVERSE DISTRIBUTION CABLE

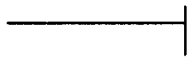

REVERSE LIGHTING CABLE



WHIP END EXTENDER CABLE



REVERSE SPLITTER

DC

DUST CAP (DC)



JUNCTION BOX- SUPPLIED BY E.C.

FIXTURES

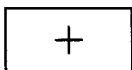

2' X 4' FLUORESCENT



2' X 4' FLUORESCENT NIGHTLIGHT

REVERSE DISTRIBUTION CABLE

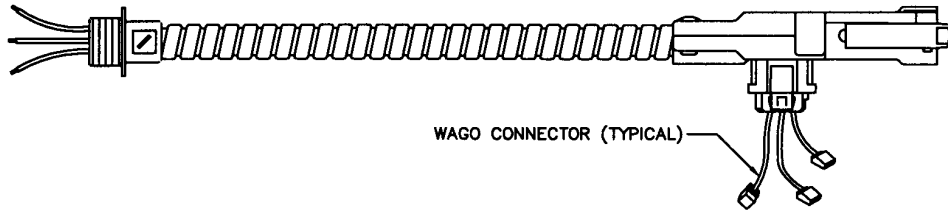

Description

The Reverse Distribution Box Cable has two (2) functions,
 1. Conversion from the hardwiring system to the modular system.
 2. Connects into the first fixture of the system to be circuited.

Example

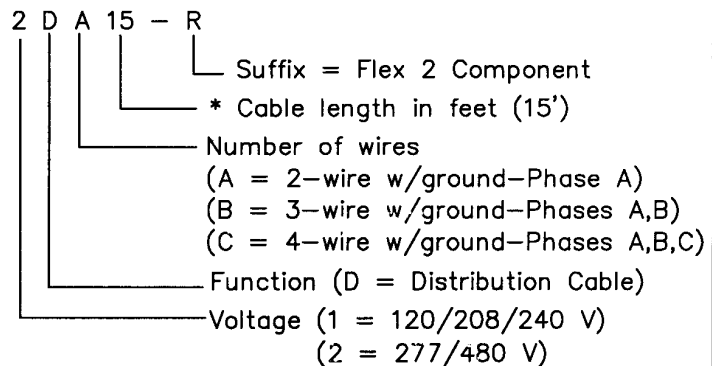

REVERSE LIGHTING CABLE

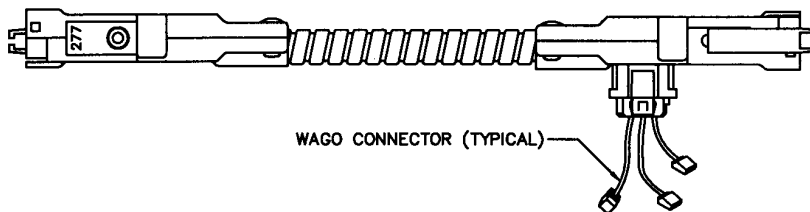

Description

The Reverse Lighting Cable extends locally or panel controlled branch circuit power to another lighting fixture in an accessible ceiling area.

Example

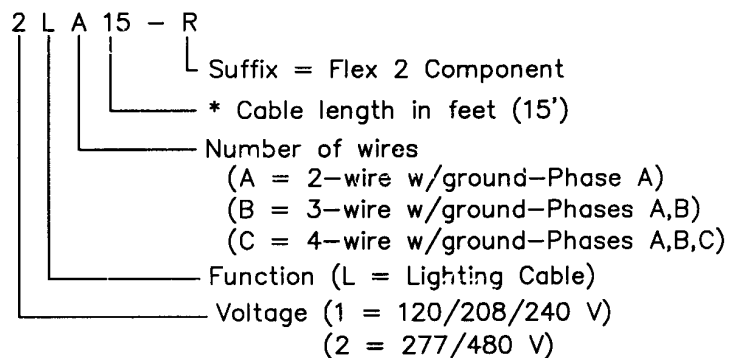

WHIP END EXTENDER CABLE

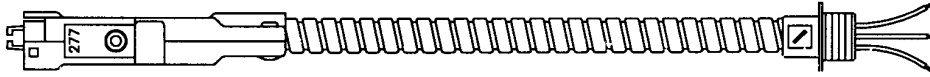

Description

The Whip End Extender Cable is used to carry branch circuit power from any "power out" tap to a non-accessible area.

Example

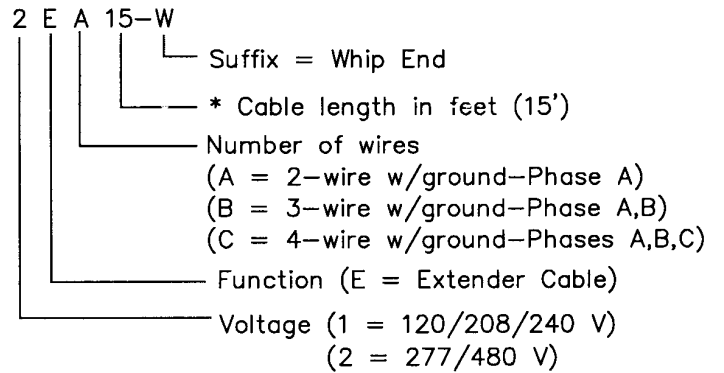

REVERSE SPLITTER

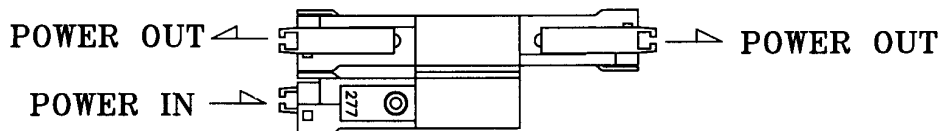

Description

The Reverse Splitter makes it possible to split a single cable run into two directions.

Example

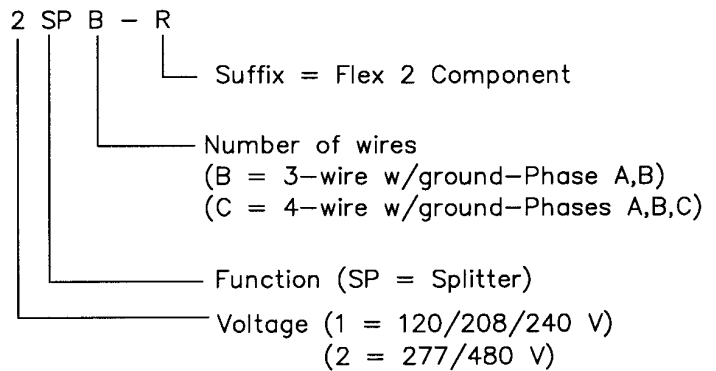

DUST CAP

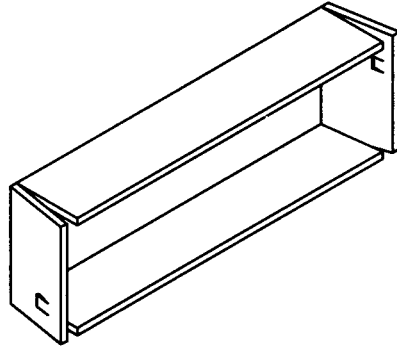

Description

The function of a Dust Cap is for capping all unused outlets or ports of a modular wiring component per Article 604 Manufactured Wiring Systems.

The Dust Cap is manufactured from .034" cold-rolled steel with zinc bright dip plating.

Example

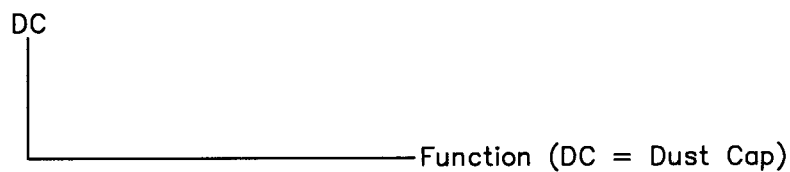

Single Circuit, Panel Switched

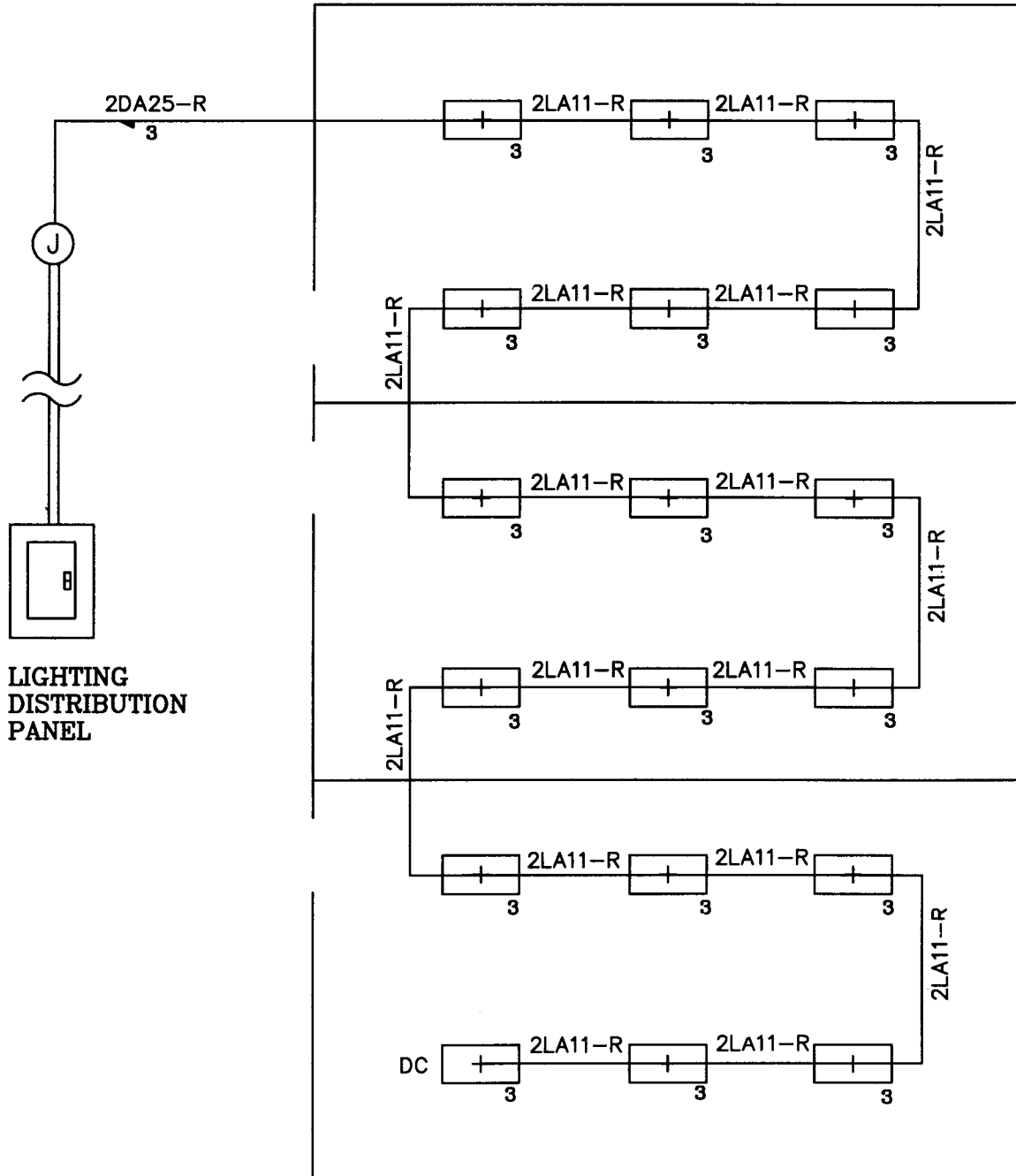

Single Level-Lighting Circuit, Panel Switched with night light

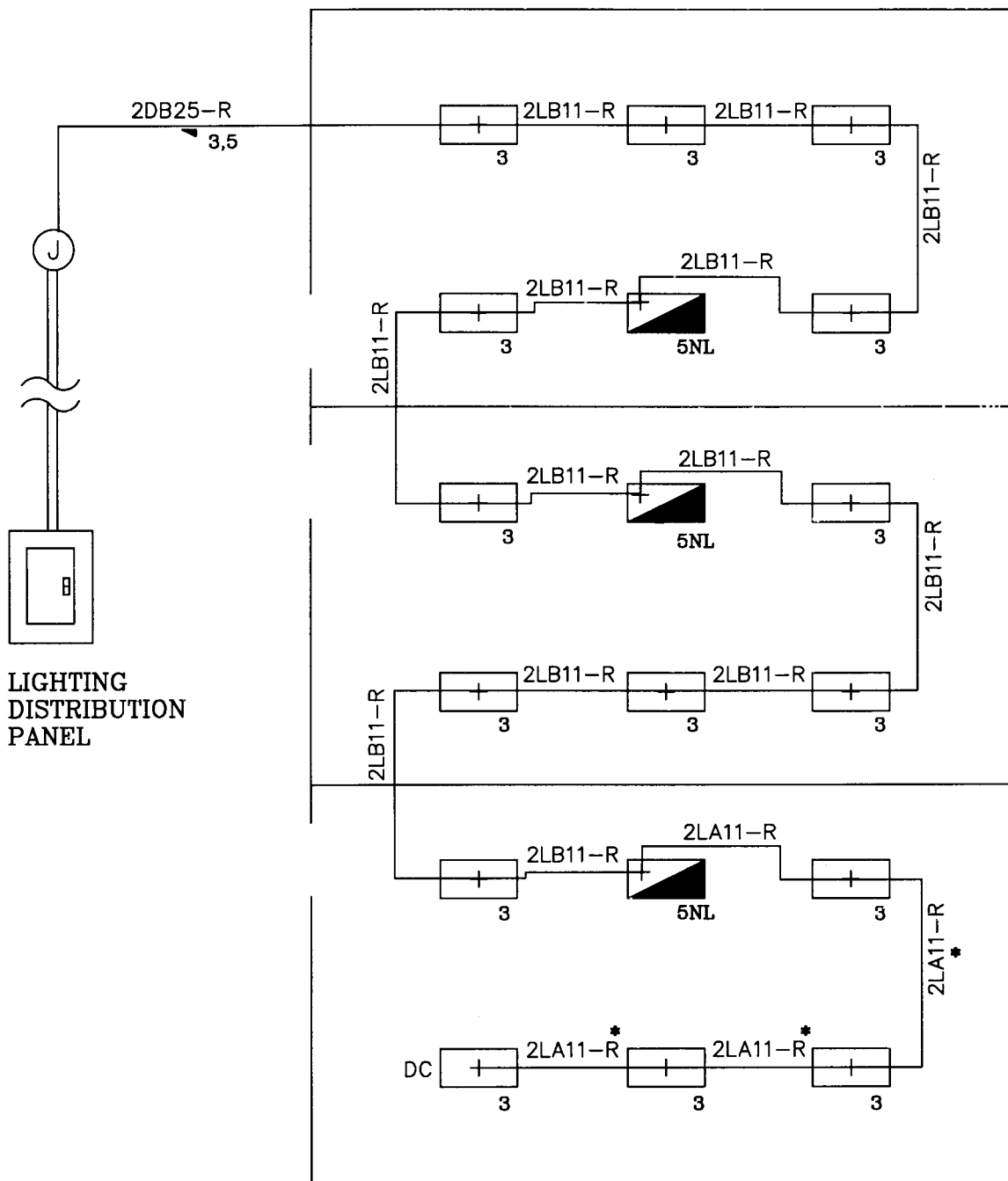

LIGHTING
DISTRIBUTION
PANEL

* "A" CABLE MINIMUM REQUIRED,
"B" CABLE RECOMMENDED—STANDARDIZATION
REDUCES HANDLING.

Dual Circuit, Panel Switched

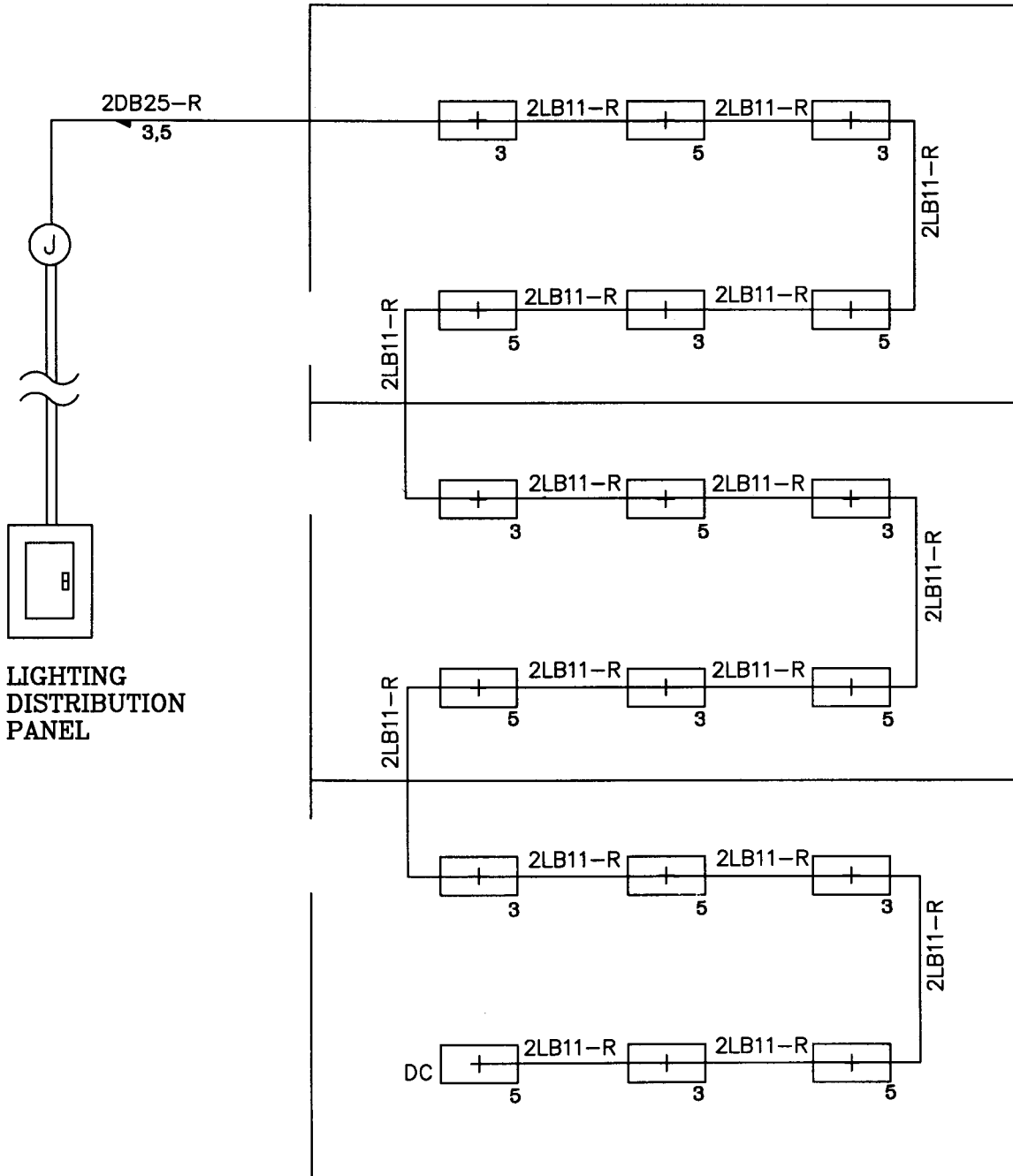

Dual Circuit, Splitter Application with Whip End Extender Cable, EXIT SIGN & CEILING/WALL MOUNTED LIGHT FIXTURES

